

Architecture Products 2008

Steller Heide 2
28790 Schwanewede
Germany

TEL.:+49 (0)421 6608478
FAX.:+49 (0)421 6608607
E-mail:info@arboinox.de
Webseite:www.arboinox.de



General Agent of  Products



ARBOINOX is a supplier of high-quality stainless steel products. We profit from the 30 year old experience of our partner company HOMER and supply since 2005 the European market with best technical materials and high requirements, to favourable prices.

We produce high-grade stainless steel parts for the yacht industry and architecture products with the emphasis building of railings, in the qualities AISI 304 /V2A and AISI 316 /V4A. Our products are conceived in our German development department. Constant controls ensure for the fact that our high quality standard is ensured on a long-term basis. With our factory in China and our warehouse in Germany, we can adjust ourselves fast to your need and guarantee an effective co-operation.

You can reach us any time, our team will always be with you as trusted customer advisers and with reliable service.

www.arboinox.de

TUBE FITTING



FITTING ROUND 90° casted AISI 304

ITEM NO.	D	L	L1	T
	mm	mm	mm	mm
A01337	Φ33.7	25	55	2.0
A17424	Φ42.4	9.4	73.6	1.2 for welding
A01424	Φ42.4	33	65	2.0
A17483	Φ48.3	15	83	1.2 for welding
A01483	Φ48.3	37	73	2.0
A01508	Φ50.8			1.6
A01510	Φ51.0			1.5

Other sizes on request

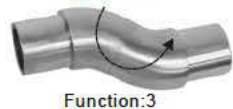
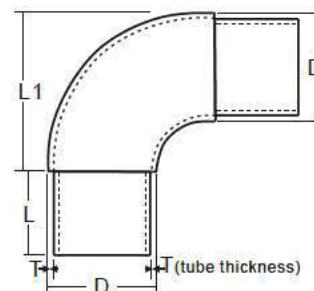

ADJUSTABLE ELBOW casted AISI 304

ITEM NO.	D	T
	mm	mm
A12508	Φ50.8	1.6
A12510	Φ51.0	1.5

Other sizes on request

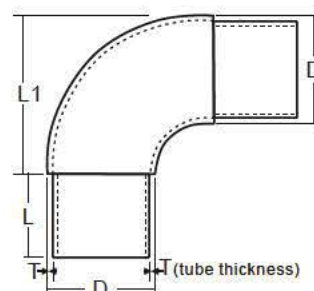

FITTING SQUARE 90° casted AISI 304

ITEM NO.	D	L	L1	L2	T
	mm	mm	mm	mm	mm
A02337	Φ33.7	25	55	20	2.0
A02424	Φ42.4	33	55	13	2.0
A02483	Φ48.3	37	61	13	2.0
A02508	Φ50.8				1.6
A02510	Φ51.0				1.5

Other sizes on request

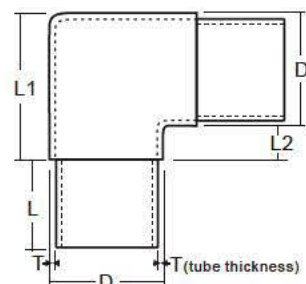

FITTING 45° casted AISI 304

ITEM NO.	D	L	L1	T
	mm	mm	mm	mm
A03337	Φ33.7	25	35	2.0
A03424	Φ42.4	33	35	2.0
A03483	Φ48.3	37	37	2.0

Other sizes on request

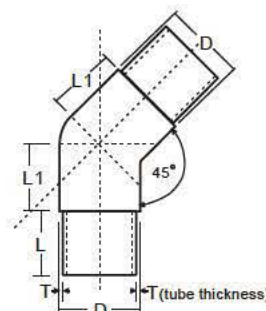

CONNECTOR casted AISI 304

for tue hollow

ITEM NO.	D	L	L1	T
	mm	mm	mm	mm
A04337	Φ33.7	43	2.7	2.0
A04424	Φ42.4	54	4	2.0
A04483	Φ48.3	80	6	2.0
A04508	Φ50.8			1.6
A04510	Φ51.0			1.5

Other sizes on request

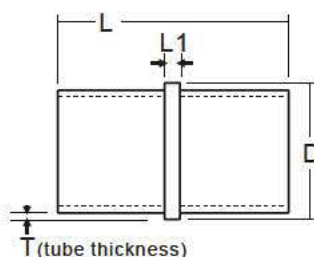



TUBE FITTING



90° TEE casted AISI 304

ITEM NO.	D	L	L1	L2	T
	mm	mm	mm	mm	mm
A05337	Φ33.7	25	75	20	2.0
A05424	Φ42.4	33	68	13	2.0
A05483	Φ48.3	37	77	13	2.0
A05508	Φ50.8	26	86	17	1.6
A05510	Φ51.0				1.5

Other sizes on request

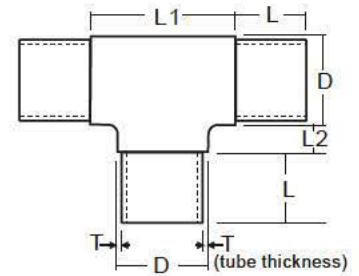

3-WAY CORNER casted AISI 304

ITEM NO.	D	L	L1	L2	T
	mm	mm	mm	mm	mm
A06337	Φ33.7	25	58	20	2.0
A06424	Φ42.4	33	55	13	2.0
A06483	Φ48.3	37	61	13	2.0
A06508	Φ50.8	26	69	16	1.6
A06510	Φ51.0				1.5

Other sizes on request

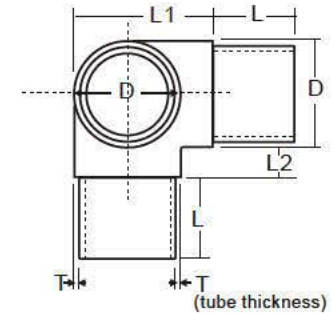

DOUBLE T casted AISI 304

ITEM NO.	D	L	L1	L2	T
	mm	mm	mm	mm	mm
A11337	Φ33.7	26	75	19.5	2.0
A11424	Φ42.4	26	89	22.5	2.0

Other sizes on request

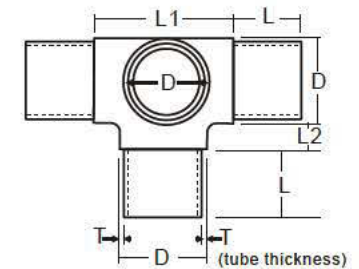

4-WAY CORNER casted AISI 304

ITEM NO.	D	L	L1	L2	T
	mm	mm	mm	mm	mm
A07337	Φ33.7	25	75	20	2.0
A07424	Φ42.4	33	68	13	2.0
A07483	Φ48.3	37	74	13	2.0
A07508	Φ50.8				1.6
A07510	Φ51.0				1.5

Other sizes on request

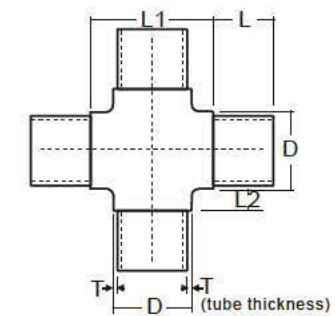

90° ROUND BASE casted

ITEM NO.	A	B	C	D	T	Quality
	mm.	mm	mm	mm	mm	
A00337	33.7	19	85	6.5	5.0	AISI 304
009769	40	39.5	84	6.8	5.0	AISI 316
A00424	42.4	19	85	6.5	5.0	AISI 304
009786	45	38.5	84	8.0	4.8	AISI 316
A00483	48.3	34	95	6.2	6.0	AISI 304
A00508	50.8	25.5	100	8.2	4.8	AISI 304
A00510	51.0	25.5	100	8.2	4.8	AISI 304

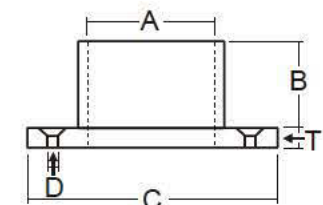

TUBE FITTING



OBLONG BASE casted AISI 304

ITEM NO.	Tube Φmm	L mm	W mm	D mm	Hole mm
A16508	50.8(2")	100	70	50.8	8.2

Other sizes on request

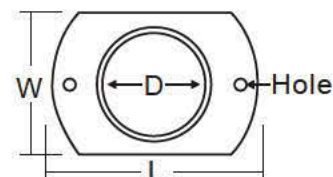

JOINTER ANY ANGLE casted AISI 304

ITEM NO.	D mm
----------	---------

A13337 Φ 33.7

A13424 Φ 42.4

Other sizes on request

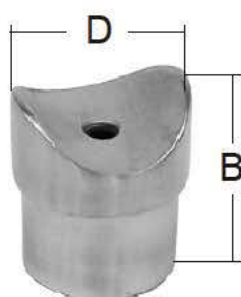

ADAPTER casted AISI 304

ITEM NO.	D mm	B mm	R mm
----------	---------	---------	---------

A18337 Φ 33.7 43.4 33.7

A18424 Φ 42.4 49 42.4

Other sizes on request

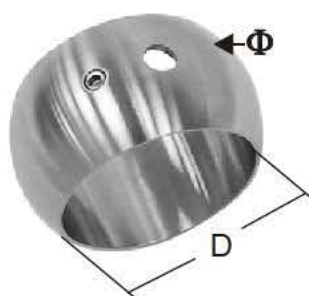
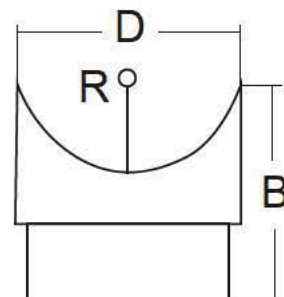

BALL RING casted AISI 304

ITEM NO.	D mm	Φ mm
----------	---------	---------

A19337 Φ 33.7 45

A19424 Φ 42.4 55

Other sizes on request

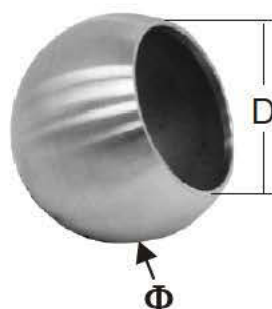

BALL SHAPED HEAD casted AISI 304

ITEM NO.	D mm	Φ mm
----------	---------	---------

A23337 Φ 33.7 Φ 45

A23424 Φ 42.4 Φ 55

Other sizes on request



TUBE FITTING

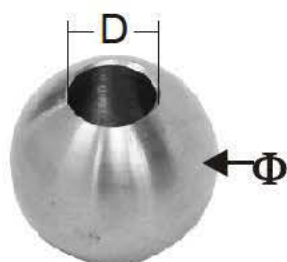

BALL WITH TAPPED BLIND HOLE

casted AISI 304

ITEM NO.	For rod	
	Φ mm	D mm
A26020	Φ20	12
A26025	Φ25	12
A26030	Φ30	12

Other sizes on request

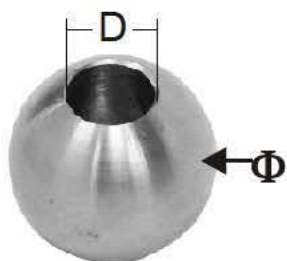

SOLID BALL WITH HOLE

casted AISI 304

ITEM NO.	For rod	
	Φ mm	D mm
A23250	Φ25	12
A23330	Φ30	12



CROSS BAR HOLDER

casted AISI 304

ITEM NO.	Connect tube	For rod
	mm	mm
A00003	Φ33.7	Φ10
A00004	Φ42.4	Φ12
A00005	Φ42.4	Φ10
A00011	Φ33.7	Φ12



CROSS BAR HOLDER

for square tube casted AISI 304

ITEM NO.	Connect	For rod mm
A00006	flat	Φ10
A00007	flat	Φ12



CROSS BAR HOLDER WITH BLIND HOLE

casted AISI 304

ITEM NO.	Tube mm	For rod mm	
A00008	Φ42.4	Φ12	Left
A00009	Φ42.4	Φ12	Right



JOINT FOR ROUND ROD $\Phi 12$ AISI 304

ITEM NO.	D mm
----------	---------

A14122 $\Phi 12$
Other sizes on request



ROD CONNECTOR casted AISI 304

ITEM NO.	For rod D mm	L mm
----------	-----------------	---------

A39100 10 36
A39120 12 36

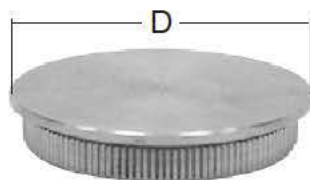

KNURLED END CAP FLAT casted AISI 304

ITEM NO.	For tube D mm
----------	------------------

A15269 $\Phi 26.9$
A15337 $\Phi 33.7$
A15424 $\Phi 42.4$
A15483 $\Phi 48.3$

Other sizes on request



KNURLED FLAT END CAP WITH M8 THREAD casted AISI 304

ITEM NO.	For tube D mm
----------	------------------

A40337 $\Phi 33.7$
A40424 $\Phi 42.4$



KNURLED END CAP OVAL SOLID casted AISI 304

ITEM NO.	For tube D mm
----------	------------------

A21269 $\Phi 26.9$
A21337 $\Phi 33.7$
A21424 $\Phi 42.4$
A21483 $\Phi 48.3$

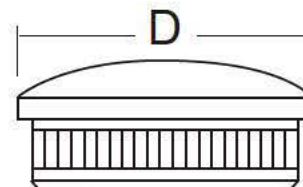

KNURLED END CAP ROUND casted AISI 304

ITEM NO.	For tube D mm
----------	------------------

A20269 $\Phi 26.9$
A20337 $\Phi 33.7$
A20424 $\Phi 42.4$

Other sizes on request



TUBE FITTING

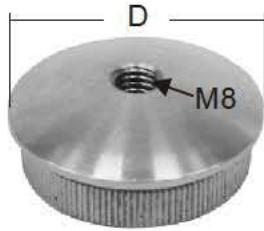

KNURLED END CAP OVAL WITH M8

THREAD **casted AISI 304**

ITEM NO.	For tube
	D mm

A28337	Φ 33.7
---------------	--------

A28424	Φ 42.4
---------------	--------

Other sizes on request



SOLID END CAP OVAL **casted AISI 304**

ITEM NO.	For tube
	D mm

A42337	Φ 33.7
---------------	--------

A42424	Φ 42.4
---------------	--------



SOLID END CAP ROUND **casted AISI 304**

ITEM NO.	For tube
	D mm

A41483	Φ48.3
---------------	-------

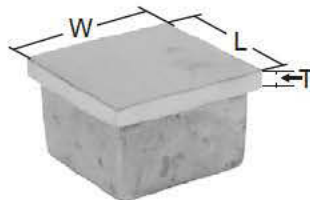

END CAP FLAT **casted AISI 304**

ITEM NO.	LxW	T
	mm	mm

A35300	30x30	5.0
---------------	-------	-----

A35400	40x40	5.0
---------------	-------	-----

A35510	51x51	5.0
---------------	-------	-----

AISI 316 on request

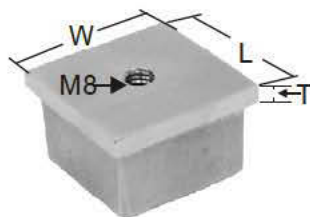

END CAP FLAT WITH 8mm THREAD

ON TOP **casted AISI 304**

ITEM NO.	LxW	T
	mm	mm

A30302	30x30	5.0
---------------	-------	-----

A30402	40x40	5.0
---------------	-------	-----

AISI 316 on request



BASE PLATE **casted AISI 304**

satin (180g) surface

ITEM NO.	Tube	L	L1	H	Hole
	mm	mm	mm	mm	mm

A25508	50.8(2")	100	50.8	30	8.0
---------------	----------	-----	------	----	-----

AISI 316 on request

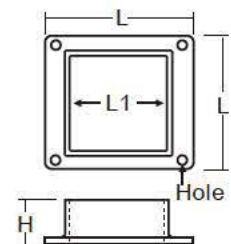

TUBE FITTING



FLUSH JOINER 90° casted AISI 304
satin (180g) finished modular handrail components

ITEM NO.	Tube mm	Wall mm	A mm	B mm	Wgt g
A32508	50.8(2")	1.5	63	50.8	655

AISI 316 on request

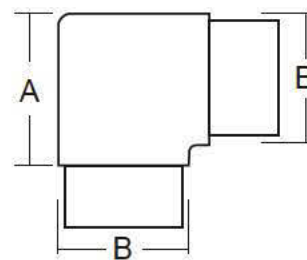

ROD WITH INTERNAL M6 THREAD AISI 304



ITEM NO.	ΦxL mm	Thread
A00101	12x65	M8
A00103	12x100	M8



ROD WITH THREAD AISI 304



ITEM NO.	ΦxL mm	Thread
A00102	12x120	M8



ROD WITH INTERNAL SQUARE AISI 304

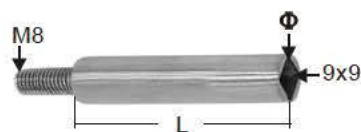

ITEM NO.	L mm	Φmm
A00104	65	13.5



CABLE CONNECTOR AISI 304

Can bent any degree for wire Φ4mm



ITEM NO.	L mm	Internal thread	wire Φmm
A00100	136	M6	4



TUBE FITTING



PLATED stamped AISI 304

to fit tube

ITEM NO. LmmxWmm

A00200 64x27

Other sizes on request

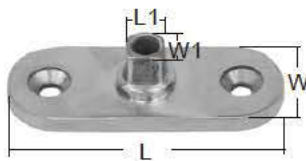

PLATE FLAT casted AISI 304

with square head

ITEM NO. L mm W mm L1 mm W1 mm

A00201 65 25 9 9

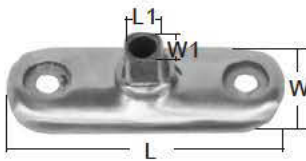

PLATE casted AISI 304

to fit tube with square head

ITEM NO. L mm W mm L1 mm W1 mm

A00202 65 25 9 9



HAND RAIL BRACKET BAIL casted AISI 304

ITEM NO. Plate mm Drilling

A08083 Φ64x4 3

A08084 Φ70x4 2 with M6 thread



HAND RAIL BRACKET BAIL AISI 304

ITEM NO. Plate mm Fit tube mm

A08082 Φ62(2-1/2") Φ42.40



GLASS CLAMP AISI 304 satin polished

ITEM NO.	L mm	W mm	Glass thickness
A08077	60	56	8 mm

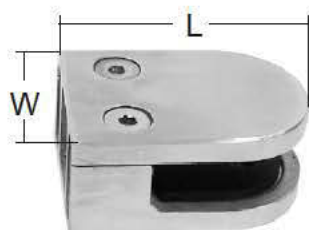

GLASS CLAMP AISI 304 satin polished

ITEM NO.	L mm	W mm	Glass thickness	Weight
A08070	63	45	10 mm	310g

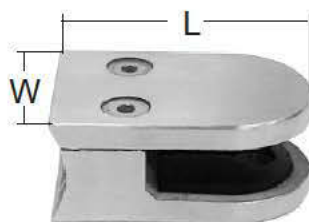

GLASS CLAMP AISI 304 satin polished

ITEM NO.	L mm	W mm	Glass thickness	Weight
A08071	67	45	10 mm	320g

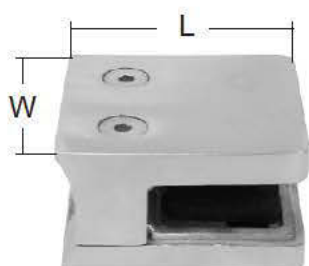

GLASS CLAMP AISI 304 satin polished

ITEM NO.	L mm	W mm	Glass thickness	Weight
A08074	60	55	8 mm	240g



DOOR GATE PLATE casted AISI 316

For door, 1set:4pcs

ITEM NO.	Size L x W x Thickness
A00010	95mmx50mmx8mm



TUBE FITTING



SPIDER casted AISI 304

One leg high polished

ITEM NO. Weight

A00040 0.79kg

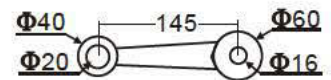

SPIDER casted AISI 304

2 leg high polished

ITEM NO. Weight

A00041 1.05kg

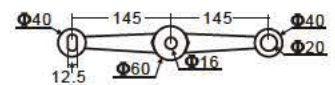

SPIDER casted AISI 304

2 leg high polished

ITEM NO. Weight

A00042 1.05kg

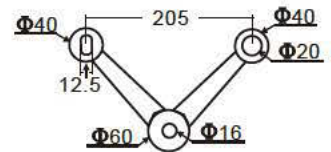

SPIDER casted AISI 304

3 leg high polished

ITEM NO. Weight

A00043 1.40kg

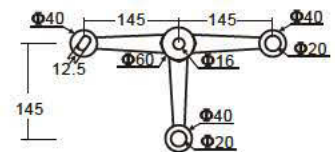

SPIDERS casted AISI 304

4 leg high polished

ITEM NO. Weight

A00044 1.80kg

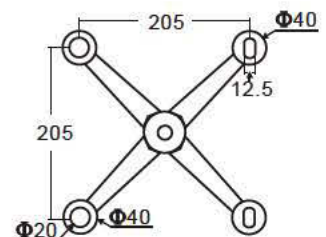



WIRE ROPE CROSS CLAMP AISI 316

ITEM NO.	Φ	D	A	M
	mm	mm	mm	mm
A08500	2	17	18	10
A08501	3	17	19	10
A08502	4	20	21	12
A08503	5	20	23	12
A08504	6	20	25	12

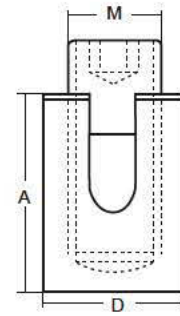

WIRE ROPE CROSS CLAMP, OPEN AISI 316

ITEM NO.	Φ	D	A	M
	mm	mm	mm	mm
A08505	2	17	18	10
A08506	3	17	19	10
A08507	4	20	21	12
A08508	5	20	23	12
A08509	6	20	25	12

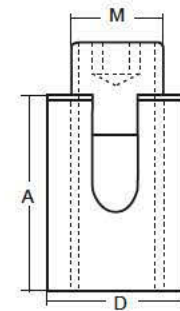

WIRE ROPE CLAMP RING AISI 316

ITEM NO.	Φ	D	A
	mm	mm	mm
A08510	3	16	10
A08511	4	16	10
A08512	5	20	10

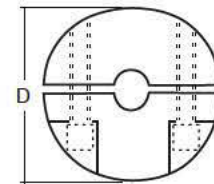

WIRE ROPE CLAMP AISI 316

ITEM NO.	Φ	D	A	M
	mm	mm	mm	mm
A08513	3	15	12	M 8
A08514	4	15	12	M 8
A08515	5	20	15	M10
A08516	6	20	15	M10

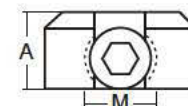
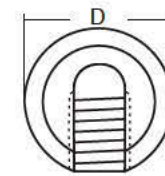



NUMBER INDEX

ITEM NO.	PAGE	ITEM NO.	PAGE	ITEM NO.	PAGE
009769	2	A05424	2	A15483	5
009786	2	A05483	2	A16508	3
A00003	4	A05508	2	A17424	1
A00004	4	A05510	2	A17483	1
A00005	4	A06337	2	A18337	3
A00006	4	A06424	2	A18424	3
A00007	4	A06483	2	A19337	3
A00008	4	A06508	2	A19424	3
A00009	4	A06510	2	A20269	5
A00010	9	A07337	2	A20337	5
A00011	4	A07424	2	A20424	5
A00040	10	A07483	2	A21269	5
A00041	10	A07508	2	A21337	5
A00042	10	A07510	2	A21424	5
A00043	10	A08070	9	A21483	5
A00044	10	A08071	9	A23250	4
A00100	7	A08074	9	A23330	4
A00101	7	A08077	9	A23337	3
A00102	7	A08082	8	A23424	3
A00103	7	A08083	8	A25508	6
A00104	7	A08084	8	A26020	4
A00200	8	A08500	11	A26025	4
A00201	8	A08501	11	A26030	4
A00202	8	A08502	11	A28337	6
A00337	2	A08503	11	A28424	6
A00424	2	A08504	11	A30302	6
A00483	2	A08505	11	A30402	6
A00508	2	A08506	11	A32508	7
A00510	2	A08507	11	A35300	6
A01337	1	A08508	11	A35400	6
A01424	1	A08509	11	A35510	6
A01483	1	A08510	11	A39100	5
A01508	1	A08511	11	A39120	5
A01510	1	A08512	11	A40337	5
A02337	1	A08513	11	A40424	5
A02424	1	A08514	11	A41483	6
A02483	1	A08515	11	A42337	6
A02508	1	A08516	11	A42424	6
A02510	1	A11337	2		
A03337	1	A11424	2		
A03424	1	A12508	1		
A03483	1	A12510	1		
A04337	1	A13337	3		
A04424	1	A13424	3		
A04483	1	A14122	5		
A04508	1	A15269	5		
A04510	1	A15337	5		
A05337	2	A15424	5		